

WIRING DIAGRAM ■ SCHEMA ELECTRIQUE

F92-ek

L21-ek with detergent pump
avec doseur de produit lessiviel

208/1 ~ 60Hz

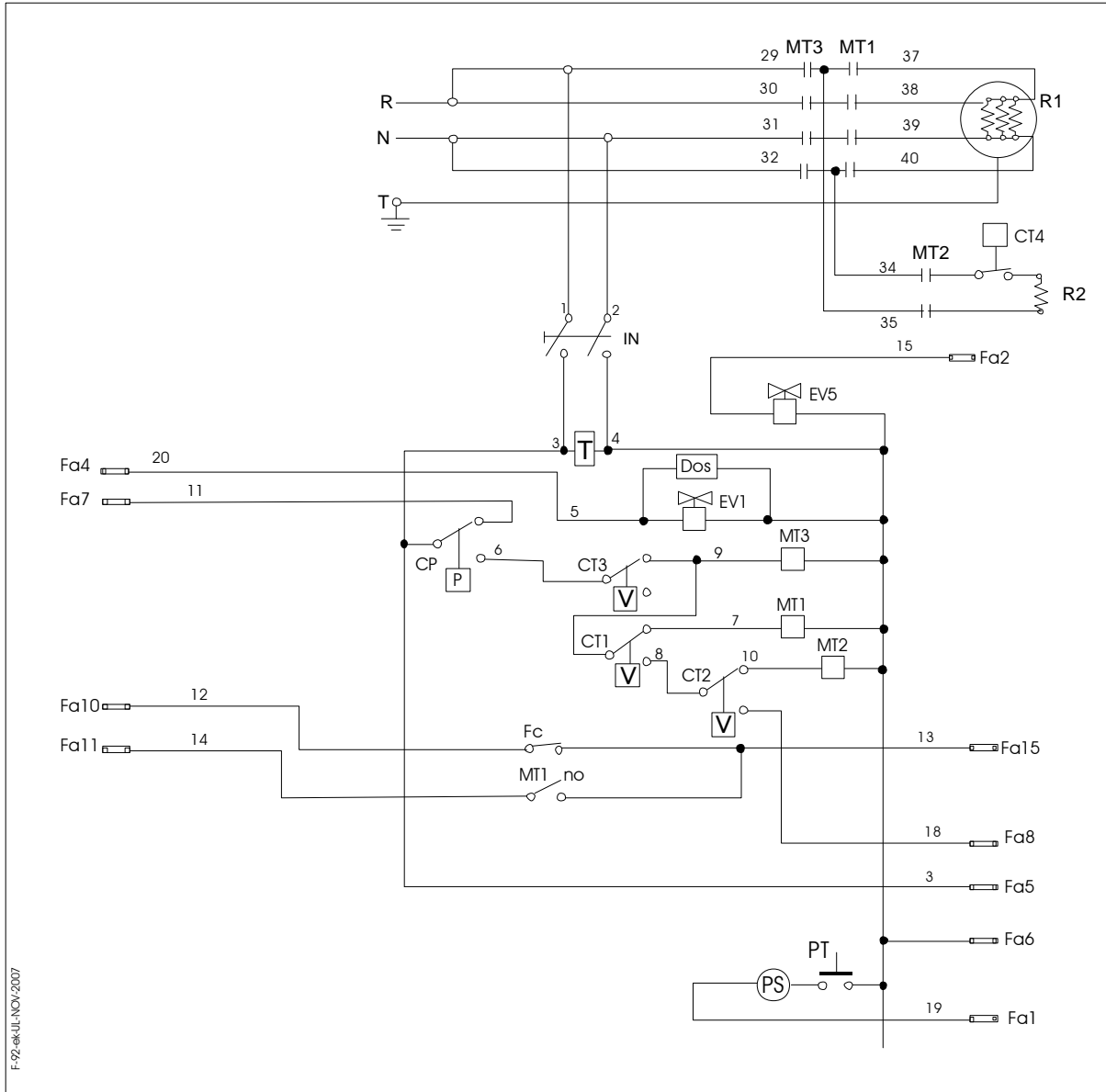

F-92-ek-LL-NOV-2007

IN	Interrupteur général	Main switch
Fc	Microinterrupteur	Limit switch
R1	Résistance Surchauffeur	Boiler elements
R2	Résistance Cuve	Tank elements
MT1	Contacteur rés. surchauffeur	Boiler elements contactor
MT2	Contacteur de sureté cuve	Tank security contactor
MT3	Contacteur de sureté	Security contactor
MT4	Contacteur Microinterrupteur	Switch contactor
CP	Pressostat	Pressure switch
CT1	Thermostat Surchauffeur	Boiler thermostat
CT2	Thermostat Cuve	Tank thermostat
CT3	Thermostat de sureté	Security thermostat
CT4	Thermostat de sureté cuve	Tank security thermostat
PM	Pompe de lavage	Electric pump
EV2	Electrovanne chargement	Loading solenoid valve
PC	Bouton cycle	Cycle pushbutton
Ad	Filtre ante-ennui	Suppressor
Dos	Doseur de produit lessiviel	Detergent pump
M1	Moteur doseur produit lessiviel	Deterg. pump timer motor
T1a-T2a	Timer doseur produit lessiviel	Detergent pump timer
M1	Petit moteur régénération	Timer motor water softener
EV1	Electrovanne rincage	Rinsing solenoid valve
EV5	Electrovanne adoucisseur	Water-softener valve
PS	Pompe de vidange	Drain pump

FICHE ELECTRONIQUE P.C.BOARD

F92-ek

	filo/fil/wire/draht	FRA	ENG
FA1	19	VIDANGE	DRAIN PUMP
FA2	15	REGENERATION	REGENERATION
FA3	16	LAVAGE	WASHING
FA4	5	RINÇAGE	RINSING
FA5	3	PHASE'	PHASE
FA6	4	NEUTRE	NEUTRAL
FA7	11	NIVEAU PRESSOSTAT	PRESSOSTAT LEVEL
FA8	18	TEMPERATURE /THERMOSTAT)	TEMPERATURE (THERMOSTAT)
FA10-FA15	12/13	MICRO PORTE	DOOR MICRO-SWITCH
FA11-FA15	13/14	THERMOCONTROL	THERMOCONTROL

**CYCLE FUNCTION
FONCTION CYCLE**

**MANUAL CYCLE
CYCLE MANUEL** ①

**AUTOMATIC CYCLE
CYCLE AUTOMATIQUE**

**REGENERATION
FUNCTION
- FONCTION
REGENERATION** ②

OFF

ON

**- WASH TIME SELECTION TABLE
- TABLEAU SELECTION TEMPS DE LAVAGE** ③

DIP	LED1=ON	LED2=ON	LED1+2=ON
	60"	120"	180"
	120"	180"	240"

SOFT-START PC-BOARD

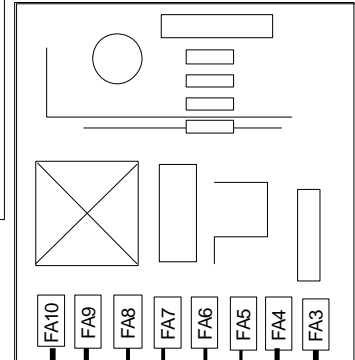

**- RINSE TIME
SELECTION TABLE
- TABLEAU SELECTION
TEMPS DE RINÇAGE** ④

DIP	
	18"
	23"

PC-BOARD

washing-lavage

rinse-rinçage

Cod.0500403

Thermometers-Thermomètres

F92-ek

F92-ek-dep
WITH WATER-SOFTENER
AVEC ADOUCISSEUR

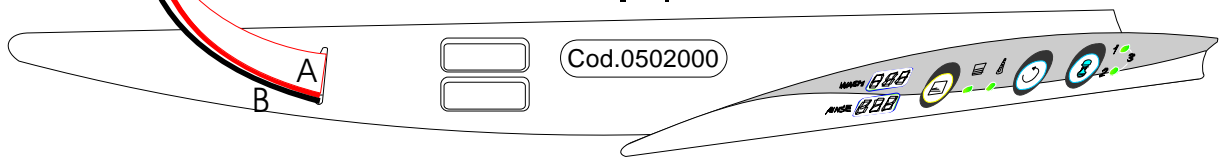
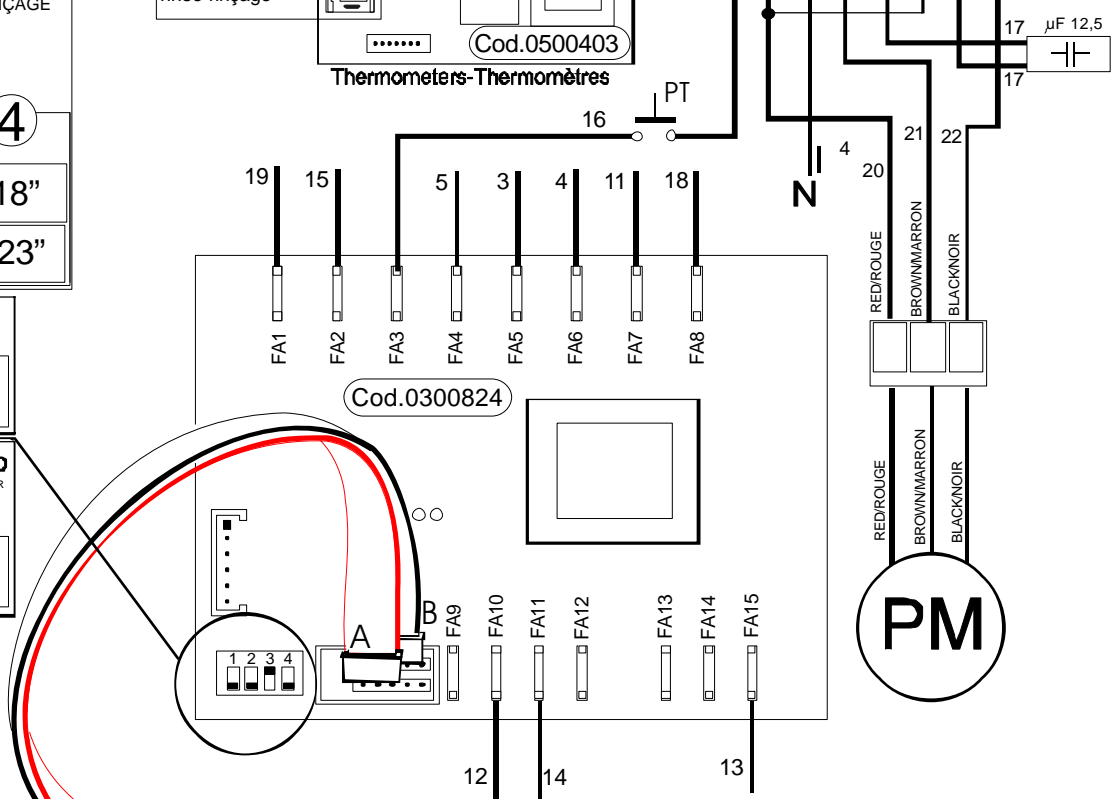

COMPONENTS COMPOSANTS



F92-ek

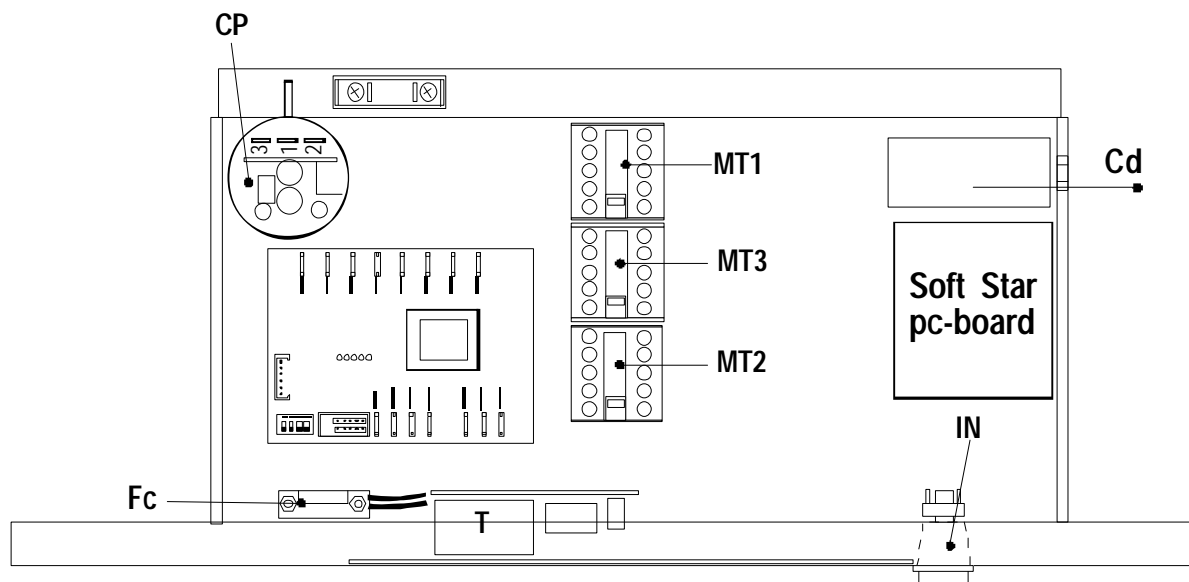

CONTROL BOARD - BOITE DE CONTROLE

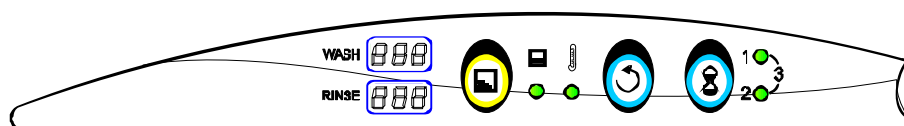

SOFT TOUCH CONTROL PANEL - PANNEAU A TOUCHES SENSITIVES

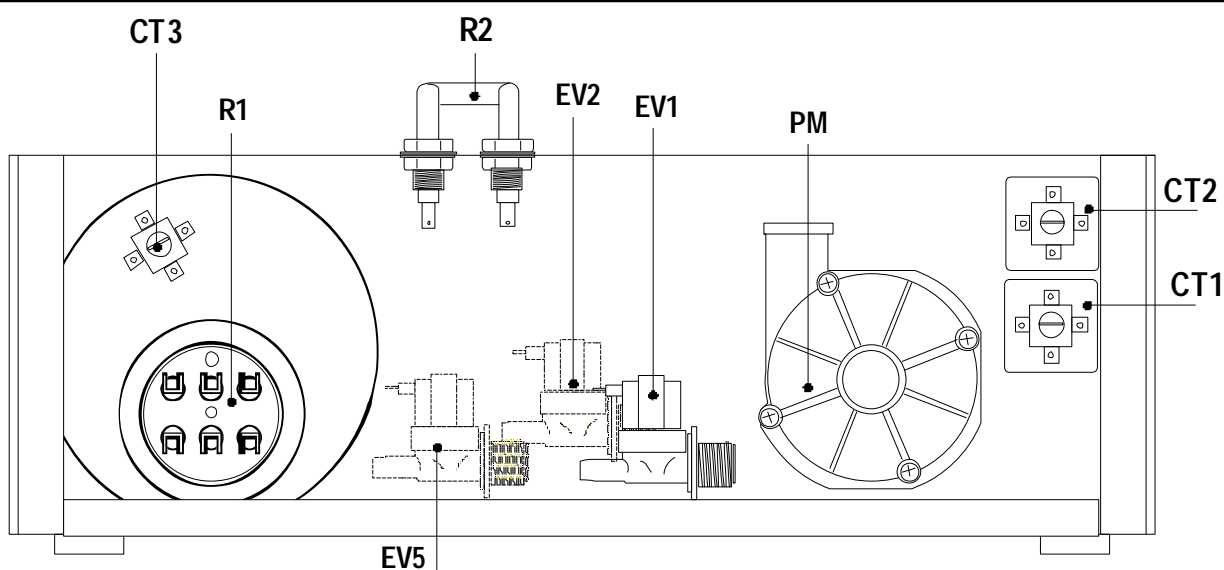

BASE - SOCLE

CONNECTIONS SCHEME ■ SCHEMA BRANCHEMENTS

